

P50 Series PANEL TRACKERBALL

Technical Drawings

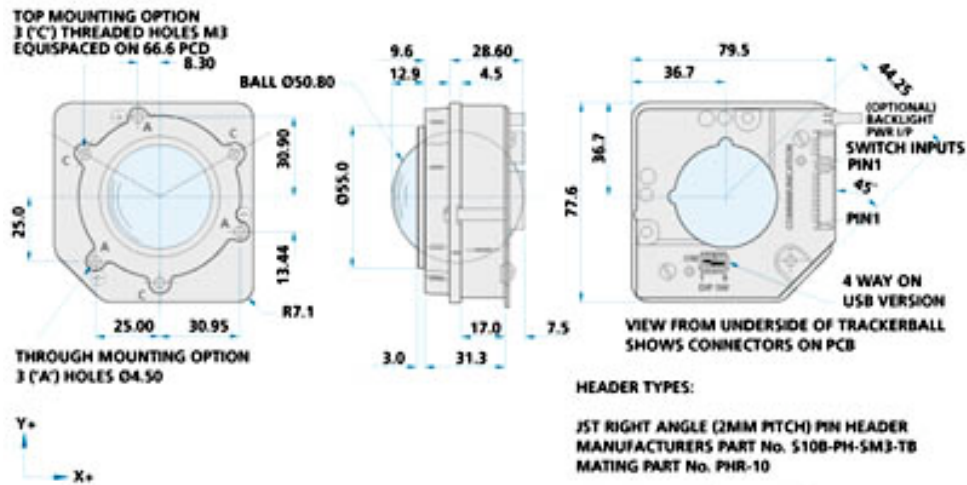

HEADER TYPES:

JST RIGHT ANGLE (2MM PITCH) PIN HEADER
MANUFACTURERS PART No. S10B-PH-SM3-TB
MATING PART No. PHR-10

JST RIGHT ANGLE (2MM PITCH) PIN HEADER
MANUFACTURERS PART No. S4B-PH-SM3-TB
MATING PART No. PHR-4

MOLEX HEADER 2-WAY RIGHT ANGLED LATCHING
MANUFACTURERS PART No. 22-05-7028